



Upright Microscope for Research ECLIPSE Ni/Ci

ECLIPSE Ni/Ci

Upright Microscope
for Research



See the evolution

The ECLIPSE Ni series, the ultimate in upright biological microscope evolution, supports bioscience studies with enhanced basic performance and flexible system expandability.

The CFI Plan Apochromat Lambda series objectives are the key to the series' optical performance. Nano Crystal Coat, with its ultra low refractive index, is employed for the first time in microscope objectives, providing brighter, high-resolution and high-contrast microscopy images.

Nikon's proprietary stratum structure allows various combinations of additional components to be installed. Applications using laser and fluorescent proteins, such as Kaede and PA-GFP, are possible with the addition of a two-tiered fluorescent unit and a photoactivation unit.

The Ni series transcends the concept of conventional upright microscopes and expands the possibilities of advanced research in fields such as bioscience and medicine.

The ECLIPSE Ci series is a compact research microscope which has highly functional and user-friendly features. Nikon provides a wide variety of research microscopes, including for shared use at research facilities and for personal use at laboratories.

Ni

■ System expandability

- Nikon's proprietary stratum structure enables efficient system construction.
- The numerous accessories can be custom combined depending upon application.

■ Optical performance

- CFI Plan Apochromat Lambda objectives with chromatic aberration correction and high transmission throughout a broad range of wavelengths
- Objectives with improved transmission in near IR wavelength range for multiphoton excitation imaging

■ Design

- 3D ergo design combines functionality with sophistication.

■ Operability

- Ni-E: Motorized model with automatic change of observation conditions and adjustment of microscope accessories.
- Ni-U: Manual model with some motorized options.
- Most microscope controls can be operated with easy-to-reach buttons on the front of the Ni-E.





Expandable system broadens application possibilities

Multi-color fluorescent imaging (Ni-E)

Demand for multi-color fluorescent imaging that uses newly developed fluorescent proteins and fluorescent reagents is constantly increasing. Nikon meets such needs with diverse functions and optical technologies.

High-speed motorized components

The higher speeds of the motorized excitation and barrier filter wheel and the motorized shutter enable quick wavelength changes, reducing photobleaching of the specimen. It can be operated via easily accessible control buttons, increasing operation efficiency.

CFI Plan Apochromat Lambda series objectives

Transmission and chromatic aberration correction have been improved throughout the wide range of visible to near IR wavelengths, allowing use of various fluorescent reagents. They provide bright, high-contrast, high S/N (signal-to-noise) ratio multi-color fluorescence images with almost no focus shift when used with any wavelength.

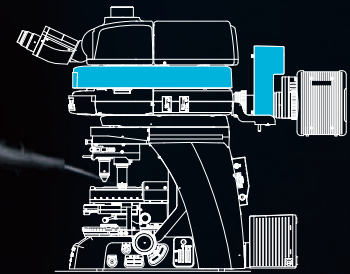

Mounted motorized excitation/barrier filter wheel

Ni-E

Multi-color
fluorescent
observation

FISH

Signal
conversion

Photoactivation imaging (Ni-E/Ni-U)

Research into the reactions and changes of stimulated cells has become popular in recent years. Nikon has developed a photoactivation unit for upright microscopes, a first in microscopy.

Flexible stratum structure

This structure allows two-layer mounting of a photoactivation unit with an epi-fluorescence attachment.

Objectives for long-wavelength laser

With CFI Plan Apochromat Lambda objectives, chromatic aberration has been corrected up to 850 nm and transmission improved in the long wavelength range, increasing accuracy and efficiency of laser excitation at target site.

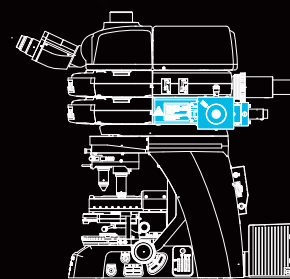

Mounted photoactivation unit

Ni-E

Ni-U

Photo-
activation

FRAP



Simultaneous multichannel imaging (Ni-E/Ni-U)

The Ni's back port and the quadrocular tilting tube allow the user to acquire simultaneous, two-channel images on separate cameras. This feature is invaluable for applications such as FRET.

■ Simultaneous imaging with two cameras

The Ni's flexible stratum structure enables incorporation of a back camera port unit, allowing simultaneous image acquisition of two different wavelengths with two different cameras mounted on the back port unit and the quadrocular tilting tube. This enables the capture of high-resolution images in the entire frame for each wavelength without dividing the CCD chip. The use of individual cameras for acquisition allows the user to tailor acquisition parameters for each channel independently, allowing acquisition of high-sensitivity FRET images.

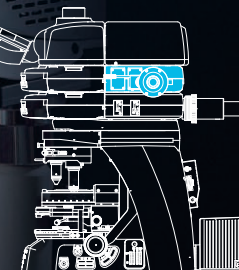

Mounted back port unit

Ni-E

Ni-U

FRET

Ratio
imaging

Multiphoton imaging (Ni-E)

Multiphoton microscopy in which long excitation wavelengths are used to allow less-invasive imaging of ever deeper areas of cells is gaining popularity. The design of the Ni-E model is optimized for multiphoton imaging in both optical and mechanical systems to meet the demands of today.



Objective dedicated to multiphoton imaging

CFI75 Apochromat 25XC W objective features chromatic aberration correction over a broad wavelength range from 405 to 950 nm, high NA (numerical aperture) (1.10) and longer working distance (2.0 mm), and compatibility with water immersion and water dipping.

High-sensitivity multiphoton detector (NDD)

This episcopic NDD (non-descanned detector) unit incorporates a detector that efficiently senses weak signals from deep areas of live specimens. In combination with a diascope NDD unit, transmitted signals can be also detected.

Retrofittable focusing nosepiece mechanism

Microscopes can be modified by switching the focusing stage and focusing nosepiece, enabling fixed-stage configuration to meet demands of experiments such as *in vivo* imaging.

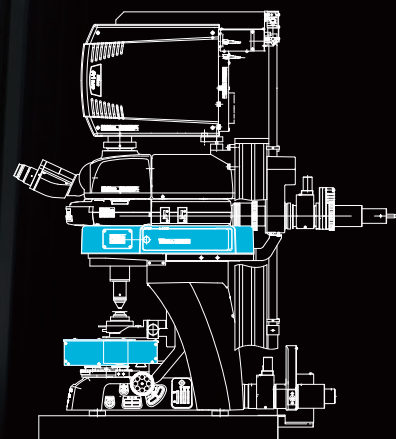

Mounted episcopic NDD unit and diascope NDD unit

Ni-E



**In vivo
imaging**

**Two-photon
imaging**

**Photo
activation**

Versatile microscopes meet all demands

Manual and motorized models

To meet diverse user demands for operability, system expandability and motorized control, Nikon provides two Ni series models. The Ni-U, which has compatibility with some motorized accessories, is the manual model suitable for high-quality image observation and digital imaging. The Ni-E is a fully motorized model that is efficient for experiments requiring comprehensive control of various devices, such as photoactivation units and confocal systems.

Ni-U (manual model)

- Ergonomic tube and stage handle height adjustment mechanism allow comfortable viewing positions.
- Stratum structure and sturdy design improve expandability.
- Motorized nosepiece, motorized epi-fluorescence cube turret, motorized shutter can be utilized.



Ni-U configured with an ergonomic binocular tube



The dedicated, simple remote control pad allows motorized changing of objectives and filter cubes, and shutter operation

Ni-E (motorized model)

- High-precision motorized focusing
- Broad range of motorized accessories that can be used in combination.
- Observation conditions can be changed at a simple push of a button.
- Stratum structure and sturdy design improve expandability.
- 3D ergo design buttons with improved operability are located close together for speedy operations.
- Microscope settings in use can be verified on the display.
- Optimized for multiphoton excitation imaging
- Two focusing mechanism options: focusing stage and focusing nosepiece

Automatic adjustment with objective changeover

Condenser, aperture and field diaphragm, and ND filter are automatically set to the optimal position during objective changeover. In addition, stage XYZ travel amount per handle rotation and parfocal distance deviation correction are automatically adjusted. Microscope settings can also be manually adjusted.

Change of observation conditions

Selected observation conditions can be designated to individual buttons, enabling changes to be made at the push of a button. This is particularly convenient when reproducing specific observation conditions.

High-precision motorized focusing

High-precision Z-focus incorporated by the Ni-E provides accurate Z-position information required for use with confocal laser microscopes. Individual coarse and fine focus knobs provide enhanced ease of operation.



Ni-E configured with a motorized epi-fluorescence cube turret and motorized universal condenser

Technologies supporting the Ni series

Supreme optical performance

As a light microscope manufacturer, Nikon has cultivated high technical capabilities and confidence. With its advanced technologies extending from optical glass production to lens design, fabrication, coating and processing, Nikon provides unsurpassed optical performance.

High-performance objective lens

● CFI Plan Apochromat Lambda series

With remarkably high NA, greatly improved transmission in the long wavelength range thanks to Nikon proprietary Nano Crystal Coat, and chromatic aberration correction over 435 to 850 nm, these objectives are ideally suited not only for brightfield and DIC observations but also for fluorescent observations. These lenses allow acquisition of bright and clear images at any wavelength for near-IR imaging and multi-color fluorescence imaging. Because bright images can be captured even with a weak excitation light, damage to a specimen is minimized.



Nano Crystal Coat

This anti-reflective coating that consists of nanometer-size particles is based on semiconductor manufacturing technology and is also used for Nikon camera lenses. The coarse structure with particles arranged in a spongy construction with uniform spaces between them enables extremely low refractive indices.

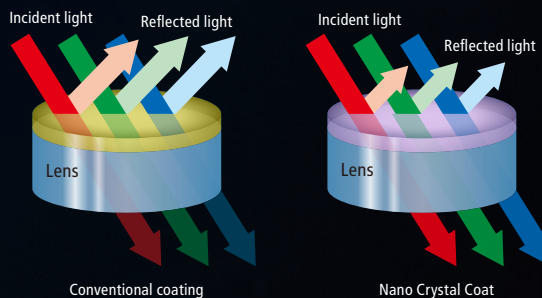
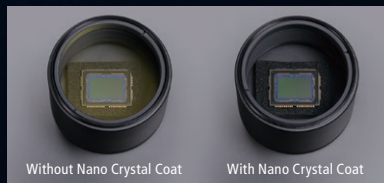

● Water dipping objective lenses

With a long working distance and high NA, these objectives provide excellent transmission in near IR wavelength range. The axial chromatic aberration of 40X and 60X objectives has been corrected to up to 850 nm, allowing high-resolution images of minute structures in thick specimens during IR-DIC observation. The 25XC W and 100X objectives feature high NA (1.1) and a long working distance (2.0 mm). With chromatic aberration corrected in the IR region, these objectives are ideal for multiphoton excitation observation. In addition, by employing a mechanism to compensate for the changes in spherical aberration that occur at different temperatures and depths of observation points, clear images of areas deep within a thick specimen can be captured.





Uniformly bright illumination

The "fly-eye" lens is ideally suited to diascope illumination optical systems. Uniform and bright illumination up to the viewfield periphery is provided at any magnification.

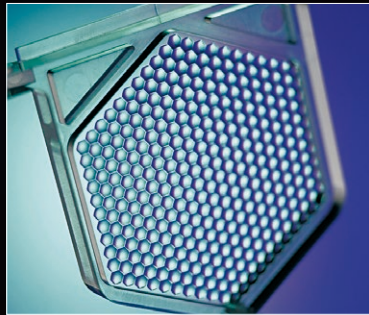

Fluorescence noise elimination

Nikon's proprietary noise terminator mechanism is employed in the epi-fluorescence cube turret and filter cubes. The S/N ratio has been dramatically improved by thoroughly eliminating stray light in the filter cubes, allowing images of weak fluorescent signals to be captured with high contrast and brightness.

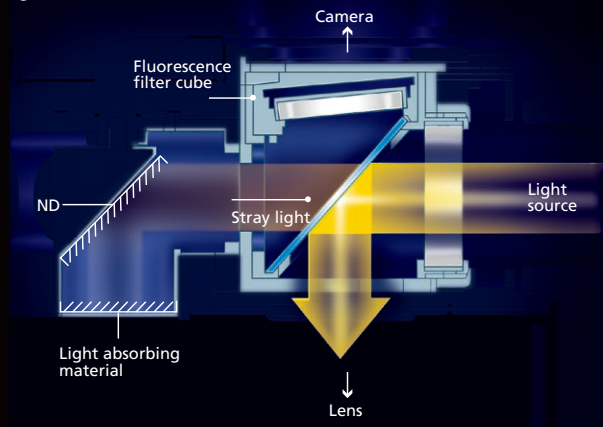

Excellent image acquisition with all observation methods

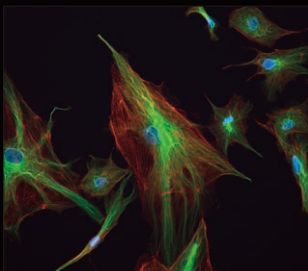

Epi-fluorescence observation

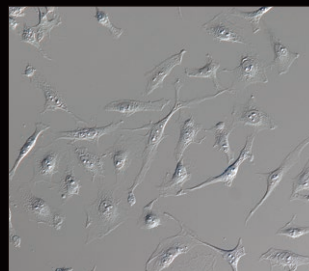
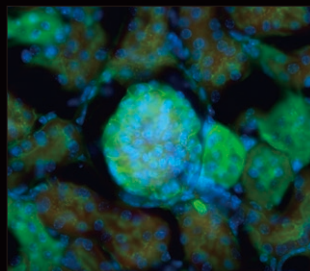

DIC (Differential Interference Contrast) observation

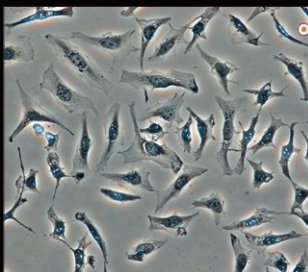
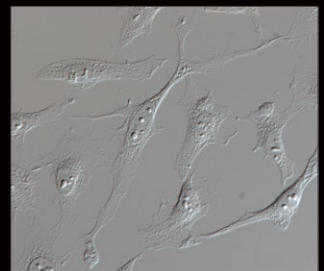

Phase contrast observation

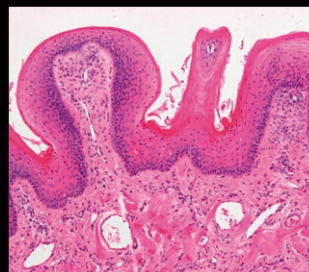
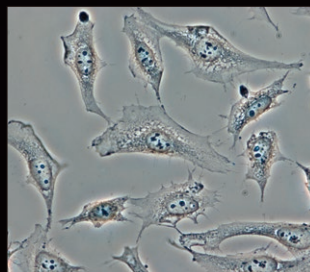

Brightfield observation

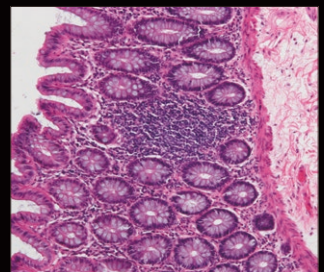

Ultimate ease, speed and clarity in imaging

Digital imaging

The Ni series can be controlled in conjunction with a Digital Sight series digital camera, facilitating effortless digital imaging. Images can be captured with a dedicated button on the microscope body. Camera control from the software GUI on a PC and the touch panel on the camera control unit is also possible.

● Image capture button

Images can be acquired by simply pressing the image capture button located on the microscope base.



● DS-L4 Microscope Camera Control Unit

The DS-L4 tablet-style camera control unit eliminates the need and space requirements of a desktop PC to control DS-Ri2 and DS-Fi3 cameras.

- Microscope status data, such as relating to the objective lens, fluorescent filter cube and condenser information, is automatically saved along with the captured image when a motorized or intelligent unit is attached.
- The touch panel allows the simple setting and operation of cameras by simply choosing the observation technique using scene mode icons.
- Simple measurement functions, such as distance measurement between two points, are available.

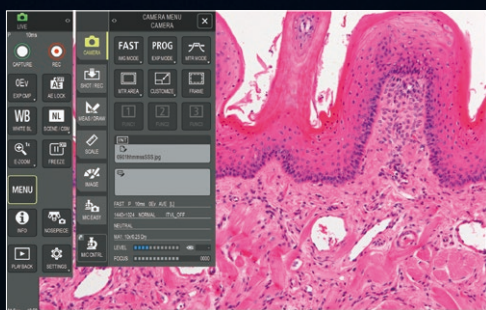

Camera setting

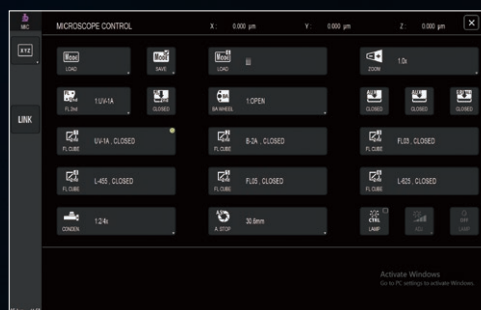

Microscope control



Simple measurement

Digital cameras for microscopes

The optimal camera for your specific imaging needs can be selected from the Digital Sight series of cameras, which offers various features such as high sensitivity, high resolution, high speed image acquisition, color reproducibility and a cooling system.

F-mount cameras

● Microscope Camera DS-Ri2

This 16.25-megapixel, high-definition camera is equipped with a Nikon FX-format CMOS sensor. The high frame rate of up to 45 fps (1636 x 1088 pixels) enables fast focusing. The image processing engine allows accurate color reproduction of microscopy images. Color fluorescent images can be clearly captured with its low-noise design.



● Monochrome Microscope Camera DS-Qi2

Equipped with monochrome CMOS sensor (16.25-megapixel). High-speed image capture of up to 45 fps (1636 x 1088 pixels). High sensitivity and superb S/N ratio design. Moreover, mounting a Peltier cooling device provides bright fluorescent images. Reliable quantitative analysis with excellent linearity.



C-mount camera

● Microscope Camera DS-Fi3

Equipped with a 5.9 megapixel CMOS image sensor. It provides high-definition imaging up to 2880 x 2048 pixels and up to 30 fps of fast imaging. With superior color reproduction and high sensitivity, images that are faithful to samples can be acquired during various observation methods, such as brightfield, DIC, phase contrast and epifluorescence.



Imaging Software NIS-Elements

NIS-Elements seamlessly integrates cameras, peripheral devices, and the Ni, serving as a powerful yet easy-to-use interface for complex imaging experiments. Powerful tools for quick processing, measurement and acquired data management provide a one-step solution for acquisition and analysis.

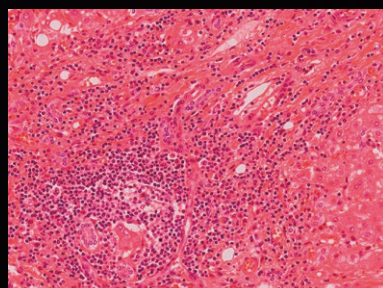
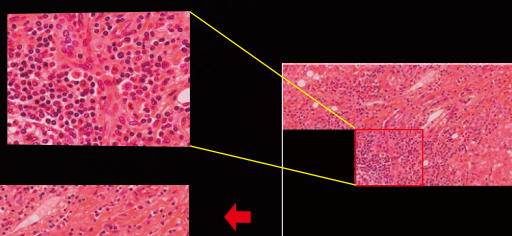
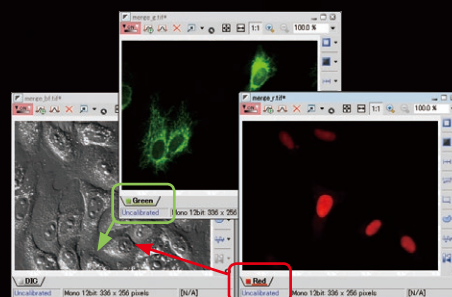
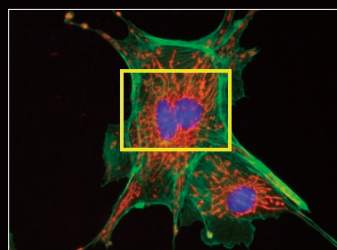

Image stitching (large image)



Merge channels



Histogram

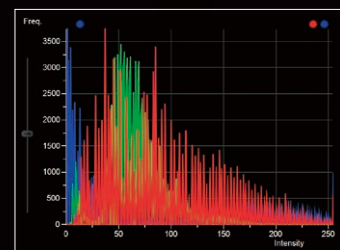

High-resolution confocal imaging systems

Combining the Ni-E's high-precision Z-focus mechanism with a confocal scanner allows high-resolution, high-S/N-ratio imaging of 3D structures of organs and cells. The Ni-E can be configured with either a focusing stage or a focusing nosepiece, catering to specific imaging requirements. Nikon offers a wide range of confocal systems that can accommodate various needs.

● Confocal microscope A1⁺/A1R⁺

A1⁺ incorporates a high-definition (up to 4096 x 4096 pixels) non-resonant scanner. A1R⁺ also incorporates a high-speed (up to 420 fps) resonant scanner, in addition to the non-resonant scanner, enabling true simultaneous photoactivation and imaging.

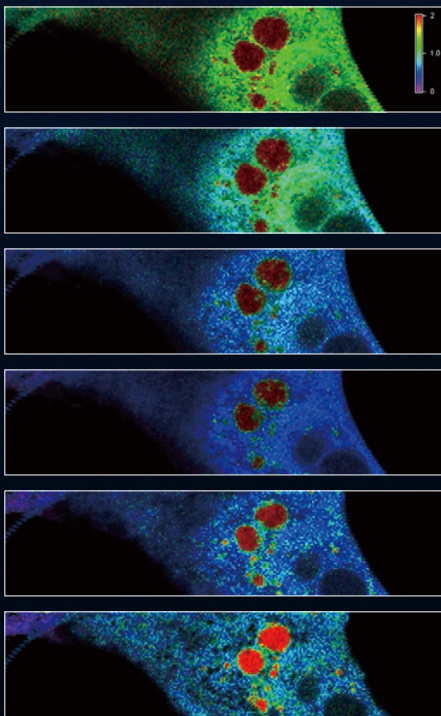

RK13 rabbit kidney epithelial cell stably transfected with the calcium biosensor Yellow Cameleon 3.6. The cell was exposed to ionomycin to raise intracellular calcium and induce FRET. The color change indicates changes in the level of FRET. Time-lapse images were taken with the A1R (resonant scanner). Sample courtesy of: Dr. Mike Davidson, National High Magnetic Field Laboratory, Florida State University

● Multiphoton confocal microscope A1 MP⁺/A1R MP⁺

High-sensitive deep imaging of living specimens is possible with A1 MP⁺'s high-resolution (up to 4096 x 4096 pixels) and A1R MP⁺'s high-speed (up to 420 fps) imaging capability. A combination of episcopic and diascope GaAsP NDDs allow more efficient acquisition of emission signals. Simultaneous excitation imaging using dual beam 1300nm-compatible IR lasers is possible.

● Confocal microscope C2⁺

C2⁺ features a compact design and high functionality. The C2⁺ allows users to acquire simultaneous 3-channel and diascope DIC images and provides powerful imaging modalities, such as large-image stitching.



Laser units with great flexibility and efficiency

LU-NV series

- Supports up to eight wavelengths and switching between seven fiber outputs.
- Lasers available for this series are: 405 nm, 445 nm, 458 nm, 488 nm, 514 nm, 532 nm, 561 nm, 594 nm, 640 nm and 647 nm.



LU-N4/N4S 4-laser unit/ LU-N3 3-laser unit

The LU-N4/LU-N4S is equipped with four lasers (405 nm, 488 nm, 561 nm, and 640 nm), while the LU-N3 has three lasers (405 nm, 488 nm, and 561 nm). The LU-N4S is compatible with spectral imaging.



Wide array of accessories finely segmented by function



Motorized quadocular tilting tube (Ni-E)
Motorized changeover of optical paths is possible. Eyepiece inclination can be adjusted from 15° to 35°.



Motorized DSC zooming port (Ni-E)
A digital camera can be mounted on the camera port. A motorized 0.6X - 2.0X zoom optical system is incorporated.



Motorized ND filter (Ni-E)
Brightness is automatically optimized with the changeover of the motorized nosepiece. Motorized adjustment of desired brightness is also possible.

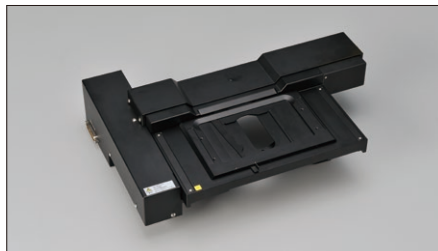

Motorized XY stage (Ni-E)
Effective for applications that require highly accurate positioning, such as photoactivation imaging and FISH.



Joystick for motorized stage (Ni-E)
Makes control of motorized XY stage possible.



Ergo controller (Ni-E)
In addition to motorized microscope operation, XYZ control of stage is possible with similar operational ease as that of an actual microscope.



Motorized universal condenser Dry (Ni-E)
High-speed motorized changeover of condenser modules for brightfield, phase contrast, DIC and simple darkfield observations is possible.



Motorized barrier filter wheel (Ni-E)
Barrier filter positions (7 positions—using 25 mm filters) can be changed at a high speed of 0.2 sec. between adjacent positions.



Motorized excitation filter wheel (Ni-E)
Excitation filter positions (8 positions—using 25mm filters) can be changed at a high speed of 0.15 sec. between adjacent positions.

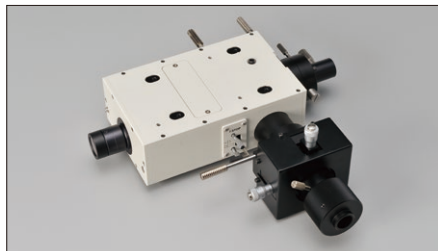

Photoactivation unit (Ni-E, Ni-U)
Laser light photoactivation and episcopic illumination are possible. Both the photoactivation unit and the confocal system can be used with a single laser source.



Back port unit (Ni-E, Ni-U)
Enables simultaneous acquisition of images with two different wavelengths using two cameras. Dedicated cubes are optional.



Motorized DIC sextuple nosepiece (Ni-E, Ni-U)
Objective magnification is automatically saved along with the captured image. Built-in prism/analyzer plate slot.



Motorized epi-fluorescence cube turret (Ni-E, Ni-U)
Noise terminator provides high S/N ratio. Six filter cubes can be installed. Either an epi-fluorescence attachment or a photoactivation unit can be attached.



Motorized shutter (Ni-E, Ni-U)
High-speed shutter control is possible. The shutter can be attached to diascopic and episcopic illumination systems.



Simple remote control pad (Ni-U)
Motorized operation of nosepiece, epi-fluorescence cube turret and shutter is possible.

Feel the evolution

Nikon has drawn on its proven optics and mechanical design technologies to develop the compact and high-performance ECLIPSE Ci series research microscope.

Ci-E/Ci-L adopts Nikon's unique, high-intensity LED as the light source for diascopic observation. High-quality objective lenses and a dedicated epi-fluorescence attachment provide bright and high contrast fluorescence images. Image capture of specimens is easy and efficient when the microscope is configured with Nikon Digital Sight series cameras. With its high-optical performance and advanced easy control, the ECLIPSE Ci series supports research using a broad range of illumination techniques including phase contrast, darkfield and simple polarizing.

Ci

- High-intensity, uniform LED illumination (Eco-illumination)
- Compact dedicated fluorescence unit
- Reliable high-performance objective lens
- Observation and image capture with comfortable posture
- Motorized magnification switching by the push of a button (Ci-E)
- Simple image capturing by the push of a button on the microscope
- Enables a wide variety of observations



Configuration of Ci-L with epi-fluorescence attachment and DS-Fi3 camera

High quality images powered by Nikon's reputed optical technologies

Nikon's well-reputed optical technologies enable the capture of sharp and high quality images in a wide variety of techniques, including brightfield and epi-fluorescence observations. The epi-fluorescence attachment of the ECLIPSE Ci series allows weakly fluorescent specimens to be captured with great clarity and brightness.

Epi-fluorescence attachment

The dedicated noise terminator for the Ci series is utilized in the compact epi-fluorescence attachment and this allows bright, high-contrast and high signal to noise (S/N) ratio fluorescence image capturing.

Two epi-fluorescence attachments are available, CI-FL (four filter cubes mountable) and D-FL (six filter cubes mountable). The name and position of the filter cubes are displayed in front of the attachment with phosphorescent labels for easy identification in darkened rooms. The filters or dichroic mirrors in the filter cubes can be easily replaced to create a more specific combination

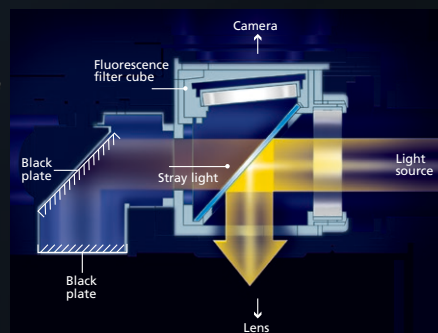
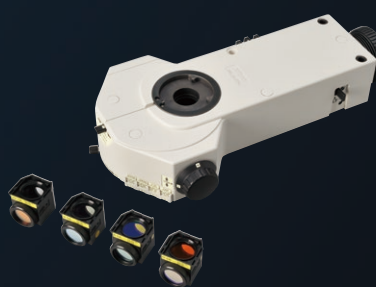

Noise terminator mechanism

High-optical performance objective lenses

● CFI Plan Achromat Lambda series

With remarkably high NA, greatly improved transmission in the long wavelength range thanks to Nikon proprietary Nano Crystal Coat*, and chromatic aberration correction over wide wavelength range, these objectives are ideally suited not only to brightfield observations but also to fluorescence observations. Bright images can be captured even with a weak excitation light, thereby reducing damage to the specimen.

* See page 10.



● CFI Plan Fluor series

Featuring an extra-high transmission rate, especially in the ultraviolet wavelength, combined with flatness of field, this series is perfect for fluorescence observation and imaging. These objectives can function as multi-purpose objectives for brightfield, fluorescence and simple/sensitive color polarizing observations.



Unparalleled basic performance

Eco-illumination

By combining a collimator lens, fly-eye optics and LED illumination, bright and uniform images up to the periphery can be obtained. The LED is a low power consumption unit that reduces lamp replacement frequency thanks to its long-life, and provides the same color temperature in every magnification.

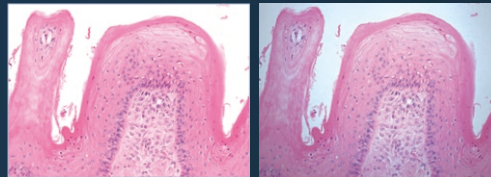
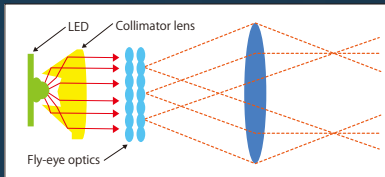

Viewed with Eco-illumination Viewed without Eco-illumination

*These images are captured without using the shading compensation to emphasize the vignetting.

Image capture button

Imaging with the Digital Sight series cameras is possible with the one touch button located on the microscope base.



Motorized model Ci-E

● Nosepiece rotating buttons

The nosepiece can be rotated with one-touch button control. In addition, your two favorite magnifications can be registered*, and one press of the button alternates between these two objective lenses.

* Using the remote control pad.



● Remote control pad

By programming specific buttons to correspond to specific objective lenses, magnification can be easily changed with a one touch button.



● Auto light intensity reproduction

The user-defined light intensity for each objective lens is automatically memorized and replicated when the objective is used again, eliminating the manual re-adjustment.

Versatile diascope observation techniques

● Phase contrast

Eco-illumination has sufficient light intensity for phase contrast microscopy that is used in a wide range of applications including dermatological examinations.



● Darkfield

Enables clear observation of blood or the minute structure of flagella. Dry- and oil-type condensers are available. The expander lens is used to obtain illumination with greater brightness.



Left: C-DD Dark Field Condenser Dry
Right: C-DO Dark Field Condenser Oil

● Simple polarizing

This is ideal for observing bi-refringent samples such as collagen, amyloids and crystals.

*Two types of analyzer are available: intermediate tube type and nosepiece slider type.



Objectives for Ni/Ci

Type	Use	Model	Immersion	NA	W.D. (mm)	Cover glass thickness	Correction ring	Spring loaded	Brightfield	Darkfield	DIC	Phase contrast	Polarizing	Fluorescence			
														Visible light	UV	NR	
Super Fluor	Brightfield (CFI Super Fluor)	4X		0.20	15.50	—			☉				△	☉	☉340		
		10X		0.50	1.20	0.17		✓	☉	○●	○		△	☉	☉340		
		20X		0.75	1.00	0.17		✓	☉	○●	○		△	☉	☉340		
		40XC		0.90	0.34-0.26	0.11-0.23	✓	✓	☉	●	○		△	☉	☉340		
		40X Oil	Oil	1.30	0.22	0.17		✓w/stopper	☉		○		△	☉	☉340		
100XS Oil	Oil	0.50-1.30	0.20	0.17		✓	☉	○●			△	☉	☉340				
Plan Fluor	Brightfield (CFI Plan Fluor)	4X		0.13	17.20	—			☉				△	☉	☉		
		10X		0.30	16.00	0.17			☉	△	○		○	☉	☉		
		20X		0.50	2.10	0.17			☉	○●	○		○	☉	☉		
		20XC MI	Oil, water, glycerin	0.75	0.51-0.35 0.51-0.34 0.49-0.33	0-0.17	✓	✓	☉	○●	○			○	☉	☉	
		40X		0.75	0.66	0.17		✓	☉	○●	○		○	☉	☉		
		40X Oil	Oil	1.30	0.24	0.17		✓w/stopper	☉		○		○	☉	☉		
		60XC		0.85	0.40-0.31	0.11-0.23	✓	✓	☉	●	○		○	☉	☉		
		60XS Oil	Oil	0.50-1.25	0.22	0.17		✓	☉	○●	○		○	☉	☉		
		100X Oil	Oil	1.30	0.16	0.17		✓w/stopper	☉		○		○	☉	☉		
		100XS Oil	Oil	0.50-1.30	0.16	0.17		✓	☉	○●	○		○	☉	☉		
Phase contrast (CFI Plan Fluor)	DLL 10X		0.30	16.00	0.17			○	△		☉ PH1		○	○			
	DLL 20X		0.50	2.10	0.17			○	○●		☉ PH1		○	○			
	DLL 40X		0.75	0.66	0.17		✓	○	○●		☉ PH2		○	○			
	DLL 100X Oil	Oil	1.30	0.16	0.17		✓w/stopper	○			☉ PH3		○	○			
Apodized phase contrast (CFI Plan Fluor)	ADH 100X Oil	Oil	1.30	0.16	0.17		✓w/stopper	○			☉ PH3		○	○			
Plan Apochromat	Brightfield (CFI Plan Apo)	Lambda 2X		0.10	8.50	—			☉				○	☉	△	☉	
		Lambda 4X		0.20	20.00	—			☉				○	☉	△	☉	
		Lambda 10X		0.45	4.00	0.17		✓	☉	△	○		○	☉	△	☉	
		Lambda 20X		0.75	1.00	0.17		✓	☉	○●	○		○	☉	△	☉	
		VC 20X		0.75	1.00	0.17		✓	☉	○●	○		○	☉	○	☉	
		Lambda 40XC		0.95	0.25-0.16	0.11-0.23	✓	✓	☉	●	○		○	☉	△	☉	
		Lambda 60XC		0.95	0.21-0.11	0.11-0.23	✓	✓	☉	●	○		○	☉	△	☉	
		Lambda 60X Oil	Oil	1.40	0.13	0.17		✓	☉		○		○	☉	△	☉	
		VC 60XC WI	Water	1.20	0.31-0.28	0.15-0.18	✓	✓	☉		○		○	☉	○	☉	
		Lambda 100X Oil	Oil	1.45	0.13	0.17		✓	☉		○		○	☉	△	☉	
	VC 100X Oil	Oil	1.40	0.13	0.17		✓	☉		○		○	☉	△	☉		
	NCG 100X Oil	Oil	1.40	0.16	0		✓	☉		○		○	☉	△	☉		
	Phase contrast (CFI Plan Apo)	DM Lambda 20X		0.75	1.00	0.17			○	○●		☉ PH2		○	△	○	
		DM Lambda 40XC		0.95	0.25-0.16	0.11-0.23	✓	✓	○	●		☉ PH2		○	△	○	
DM Lambda 60XC			0.95	0.21-0.11	0.11-0.23	✓	✓	○	●		☉ PH2		○	△	○		
DM Lambda 60X Oil		Oil	1.40	0.13	0.17		✓	○	●		☉ PH3		○	△	○		
DM Lambda 100X Oil	Oil	1.45	0.13	0.17		✓	○			☉ PH3		○	△	○			
Apochromat	Confocal (CFI Apo)	Lambda S 60X Oil	Oil	1.40	0.14	0.17		✓	☉		○		○	☉	☉		

Use: Clearing *3	Model	Immersion	NA	W.D. (mm)	Cover glass thickness	Correction ring	Spring loaded	Brightfield	Darkfield	DIC	Phase contrast	Polarizing	Fluorescence		
													Visible light	UV	NIR
Multiphoton Confocal (CFI Plan Apo)	10XC Glyc	Water, Oil, Glycerin	0.50	5.50	0-0.17	✓*1		☉	○●				☉		☉
Multiphoton (CFI 90)	20XC Glyc	Glycerin	1.00	8.20	—	✓*2		△*4							☉

Use: Water dipping *3	Model	Immersion	NA	W.D. (mm)	Cover glass thickness	Correction ring	Spring loaded	Brightfield	Darkfield	DIC	Phase contrast	Polarizing	Fluorescence			Near-infrared DIC
													Visible light	UV		
Multiphoton Confocal (CFI75 Apo)	25XC W	Water	1.10	2.00	0	✓		☉	●	○		○	☉	○	○	○
	25XC W 1300	Water	1.10	2.00	0	✓		☉	●	○		○	☉	○	○	○
DIC (CFI Plan Fluor)	10X W	Water	0.30	3.50	0			☉	△	○		○	☉	☉	○	○
IR-DIC (CFI Apo)	NIR 40X W	Water	0.80	3.50	0			☉	●	○		○	☉	△	☉	○
	NIR 60X W	Water	1.00	2.80	0			☉	●	○		○	☉	○	☉	○
DIC (CFI Plan)	100XC W	Water	1.10	2.50	0	✓		☉	●	○		○	☉	○	○	○
Phase contrast (CFI Fluor)	DLL 40X W	Water	0.80	2.00	0			○	●		☉ PH2		○	○	○	○
DIC (CFI75)	LWD 16X W	Water	0.80	3.00	0			☉	●	○		○	☉	○	○	○

Note 1. Model name
The below letters, when included in the model names, indicate the respective features.
C: with correction ring
NCG: for use without cover glass
S: with iris
WI: water immersion type
W: water dipping type
Mi: multi immersion (oil, water, glycerin) type

Note 2. Cover glass thickness
—: can be used without cover glass
0: use without cover glass

Note 3. Darkfield microscopy

Note 4. Phase rings are classified by objective NA
PH1, PH1, PH2, PH3: condenser cassette modules.

Note 5. Fluorescence microscopy (UV)
△: possible with visible light that has a longer wavelength than the excitation light used for DAPI
○: suitable
☉: recommended for best results
340: high transmittance with an ultraviolet wavelength range of up to 340nm

Note 6. Brightfield/DIC/Fluorescence (visible light) microscopy
△: possible but not recommended
○: suitable
☉: recommended for best results

Note 7. Polarizing
△: possible but not recommended
○: suitable
☉: retardation measurement is possible with a polarizing microscope

Note 8. Ti2-E PFS
●: compatible with PFS
*1 With correction for refractive index of immersion medium (1.33-1.51)
*2 With correction for refractive index of immersion medium (1.44-1.50)
*3 For Ni-E focusing nosepiece type
*4 Correction wavelength range: from 587nm, can be used as a finder

Epi-fluorescence light sources for Ni/Ci

Epi-FI LED illuminator

The LED illuminator ensures stable and quantitative brightness of illumination and operational simplicity. It is particularly suited to long periods of fluorescence time-lapse imaging.

C-LEDFI Epi-FI LED Illuminator

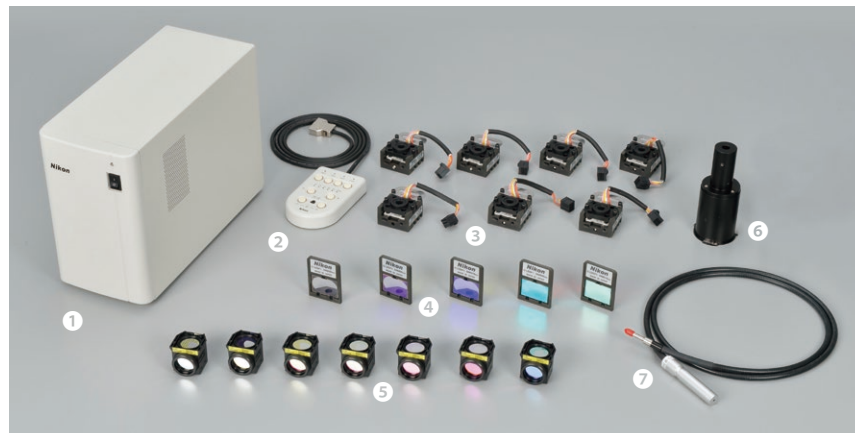

- 1 Epi-FI LED Illuminator main unit
- 2 Simple remote control pad
- 3 LED unit
- 4 Dichroic mirror unit
- 5 Epi-FI Filter Cube
- 6 HG100W Adapter R
- 7 Fiber (1.5 m/3.0 m)

Stable light intensity

Stable illumination brightness ensures quantitative and reliable fluorescence intensity measurement.

The LED illuminator ensures minimal output fluctuation of less than 0.1% in 100 Hz (10 ms.). In addition, it maintains output fluctuation at below 3% even when the illuminator is switched on and off intermittently over 72 hours of time-lapse observation.

Zero warm-up time

The illuminator requires zero warm-up time and enables observation immediately after it is switched on. Thus it can even be employed only when capturing images during time-lapse imaging, thereby eliminating the need for fluorescence shutters.

Wavelength intensity control

The illuminator allows for a flexible combination of LED units, enabling simultaneous lighting with multiple wavelengths for multi-color observation. The intensity of the excitation LED light for each wavelength can be consecutively controlled, thereby eliminating the need for ND filters.

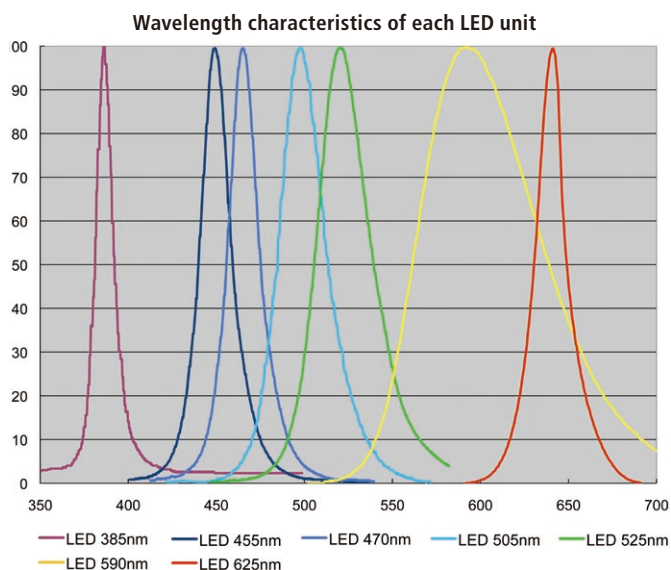

Control with NIS-Elements software

Turning the illuminator on and off and changing wavelengths in synchronization with image acquisition is possible with NIS-Elements imaging software.

Maintenance free

An LED has a minimum lifespan of 10,000 hours, eliminating the need for frequent lamp replacement.

Alignment free

The LED and dichroic units do not need to be aligned each time they are changed over. Furthermore, the Epi-FI LED Illuminator is connected to the microscope fluorescent attachment using a dedicated optical fiber cable, eliminating the need to center the light source.

Specifications

LED unit	7 types; up to 4 units can be assembled 385/455/470/505/525/590/625 nm	
Dichroic mirror unit	5 types, up to 3 units can be assembled 425/455/470/565/610 nm	
Fiber	Two types (1.5 m or 3.0 m)	
LED control	Simple remote control pad	Selection and ON/OFF of LED unit is possible. (Simultaneous lighting of multiple LEDs and light intensity control for each LED unit is possible.) Light intensity control step: 7 steps (0, 10, 20, 40, 60, 80, 100%)
	NIS-Elements software	Selection and ON/OFF of LED unit is possible. (Simultaneous lighting of multiple LEDs is possible.) Light intensity control step: Minimum 0.5% linear control Intensity control of multiple LED units while retaining intensity ratios is possible. LED excitation in synchronization with image acquisition using CCD camera (time-lapse imaging) Trigger Acquisition function available
ON/OFF switching speed	Less than 100 μ s	
LED auto detection	Automatic detection and display of LED unit (using NIS-Elements)	
LED lifetime	Over 10,000 hours	
External dimensions	135 (W) x 227 (H) x 303 (D) mm	
Weight	Approx. 5.4 kg	

HG Precentered Fiber Illuminator Intensilight

The Intensilight high-intensity mercury-fiber illuminator employs a precentered, long-life lamp that requires no centering while allowing users to capture high-quality fluorescence images with uniform brightness.



Precentered lamp requires no alignment

The use of a precentered lamp and dedicated optical fibers eliminates the need for cumbersome centering and focusing operations, even after the lamp is replaced. Uniform brightness is always assured.

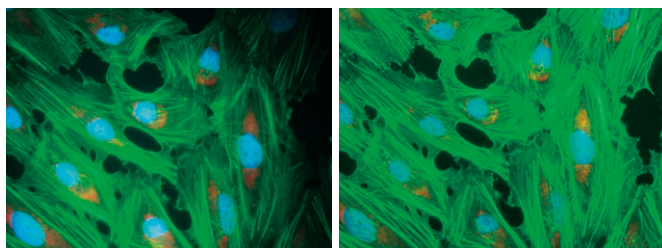

Off-center

Precentered

2000-hour long-life lamp

The lamp lasts an average of 2000 hours, or 10 times longer than conventional mercury lamps. Therefore, replacement costs and microscope downtime are greatly reduced.

Reduced heat and electrical noise

Dedicated optical fibers (1.5 m, 3 m) allow the light source to be placed away from the microscope, reducing heat and electrical noise on the microscope body. This is particularly suited to long-time fluorescence observation (time-lapse observation) of live cells.

Greatly increased brightness for green spectrum

At wavelengths of around 450 nm to 500 nm, brightness is much higher than that of a conventional mercury lamp, making the lamp ideally suited to observation of green fluorescence such as FITC and GFP.

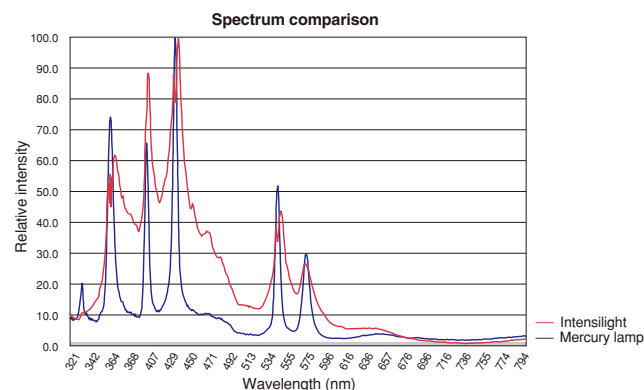

Shutter and light intensity control

There are six levels of light intensity to choose from depending on the specimen. The shutter allows light to the specimen to be easily shut off without the power being turned off. Therefore, photobleaching can be reduced to a minimum when observing multi-stained specimens.

Safety measures

When the lamp replacement cover is open or the optical fibers are not attached, the interlock automatically shuts the light off to protect the user from possible light exposure. Furthermore, when the lamp temperature sensor detects abnormally high temperatures, power is cut to protect the lamp.

DC lighting for constant light intensity

As DC (direct current) lighting is less influenced by frequency than AC (alternating current) lighting, DC provides constant, nonfluctuating light.

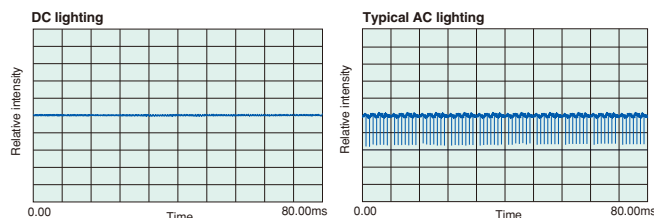

Motorized model C-HGFI available

The light intensity and shutter can be controlled from an optional dedicated remote controller or a PC that incorporates Nikon's NIS-Elements imaging software. The light intensity and shutter can be programmed for each application and controlled in conjunction with the microscope and peripheral equipment. This enables automatic control during excitation light changeover and observation of multi-stained specimens.

Specifications

Lamp	Ultrahigh pressure 130 W mercury lamp
Lamp life	Average 2000 hours
ND (light intensity)	1 (100%), 2 (50%), 4 (25%), 8 (12%), 16 (6%), 32 (3%)
Shutter response	(Motorized) 100 msec
Power supply	100-240 VAC 50/60 Hz
Dimensions (including protrusions)	(Manual) 110 (W) x 307 (D) x 278.5 (H) mm (Motorized) 110 (W) x 296 (D) x 278.5 (H) mm
Weight	Approx. 6 kg
Optical fiber length	1.5 m/3.0 m

Ni Specifications

		Ni-E		Ni-U
		Focusing stage type	Focusing nosepiece type	
Main body	Optical system	CFI60 infinity optical system	CFI60 and CFI75 infinity optical systems	CFI60 infinity optical system
	Focusing (stroke from focus point)	Via motorized stage Up/Down movement (Up 2 mm/Down 13 mm)	Via motorized nosepiece Up/Down movement (Up 13 mm/Down 2 mm)	Via manual stage Up/Down movement (Up 3 mm/Down 26 mm)
		Built-in linear encoder, Resolution: 0.025 μm Motorized escape and refocus mechanism		
		Coaxial Coarse/Fine focusing		
	Illumination	Halogen lamp (12V100W) · NI-ND-E Motorized ND Filter (option)		Halogen lamp (12V100W)
		Built-in fly-eye lens Built-in NCB11, ND8, ND32 filters (detachable, one additional filter mountable) and diffuser (non-detachable) ND2 filter (option)		
Controls	Transmitted light On/Off switch, Intensity control dial with preset function Image capture button		—	
	Built-in motorized control switches			
Power supply unit	· DS-L4 Microscope Camera Control Unit · NI-ERG NI Ergo Controller (option)		· DS-L4 Microscope Camera Control Unit (option) · NI-SRCP Simple Remote Control Pad (option)	
	External power supply NI-CTLA Control Box A for all configurations			
Eyepieces (F.O.V. mm)		· CFI 10X (22) · CFI 12.5X (16) · CFI 15X (14.5) · CFI UW10X (25)		
Tubes	F.O.V. 22 mm (Eyepiece/Port)	· C-TB Binocular Tube · C-TE2 Ergonomic Binocular Tube (100/0, 50/50 with C-TEP2 DSC Port or C-TEP3 DSC Port C-0.55X) Inclination angle: 10-30 degree, Extension up to 40 mm		
	F.O.V. 25 mm ¹ (Eyepiece/Port)	· C-TF Trinocular Tube F (100/0, 0/100) · C-TT Trinocular Tube T (100/0, 20/80, 0/100) · C-TT-C Trinocular Tube (100/0, 0/100, for confocal) ^{1,2} · LV-TI3 Trinocular ESD Tube T (100/0, 0/100) · NI-TT Quadrocular Tilting Tube (Eyepiece/Upper port/Rear port: 100/0/0, 0/100/0, 0/0/100) Inclination angle: 15-35 degree		
		· NI-TT-E Motorized Quadrocular Tilting Tube (Eyepiece/Upper port/Rear port: 100/0/0, 0/100/0, 0/0/100) Inclination angle: 15-35 degree		
Ports (F.O.V. 11 mm)	· C-TEP2 DSC Port for Ergonomic Binocular Tube (with C-mount adapter, 0.7X) · C-TEP3 DSC Port C-0.55X for Ergonomic Binocular Tube (with C-mount adapter, 0.55X) · C-TEPF2.5 DSC Port F2.5X for Ergonomic Binocular Tube (with F-mount adapter, 2.5X) · NI-BPU Back Port Unit (with C-mount adapter, 1.0X) · NI-RPZ DSC Zooming Port for Quadrocular Tube (with C-mount adapter, manual zoom, 0.6X - 2.0X) · NI-BPU Back Port Unit (with C-mount adapter, 1X)			
	· NI-RPZ-E Motorized DSC Zooming Port for Quadrocular Tube (with C-mount adapter, motorized zoom, 0.6X - 2.0X)			
Arms		· NI-SAM Standard Arm · NIE-CAM Contact Arm (for Motorized/Intelligent options)		· NIU-CAM Contact Arm (for Motorized/Intelligent options)
Nosepieces	Motorized	· NI-N7-E Motorized Septuple Nosepiece · NI-ND6-E Motorized DIC Sextuple Nosepiece	—	· NI-N7-E Motorized Septuple Nosepiece · NI-ND6-E Motorized DIC Sextuple Nosepiece
	Intelligent	· NI-N7-I Intelligent Septuple Nosepiece · NI-ND6-I Intelligent DIC Sextuple Nosepiece	—	· NI-N7-I Intelligent Septuple Nosepiece · NI-ND6-I Intelligent DIC Sextuple Nosepiece
	Manual	· D-ND6 DIC Sextuple Nosepiece · C-N6 ESD Sextuple Nosepiece ESD · C-N6A Sextuple Nosepiece with Analyzer Slot · LV-NU5 Universal Quintuple Nosepiece ESD · LV-NBD5 BD Quintuple Nosepiece ESD	· FN-S2N 2 Place Sliding Nosepiece (for CFI60 objectives) Changeover 2 objectives, DIC slider insertable · FN-MN-H CFI 75 Holder (for CFI75 objective) DIC slider insertable · FN-MN-H2 CFI 90 Holder (for CFI90 objective)	· D-ND6 DIC Sextuple Nosepiece · C-N6 ESD Sextuple Nosepiece ESD · C-N6A Sextuple Nosepiece with Analyzer Slot · LV-NU5 Universal Quintuple Nosepiece ESD · LV-NBD5 BD Quintuple Nosepiece ESD

Ni Dimensional diagram

Ni-E (for use with focusing nosepiece)

Configured with an Ni photoactivation unit, two-tiered motorized epi-fluorescence cube turret and motorized quadrocular tilting tube

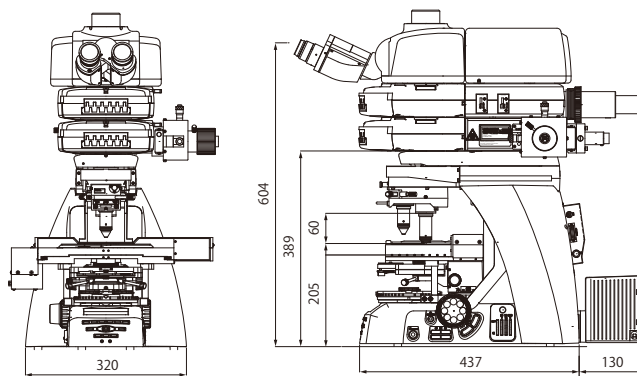

		Ni-E		Ni-U
		Focusing stage type	Focusing nosepiece type	
Stages		<ul style="list-style-type: none"> · NIE-CSRR2 Right Handle Rotatable Ceramic-coated Stage with 2S Holder Cross travel 78(X) x 54(Y) mm Handle height and torque adjustable 	<ul style="list-style-type: none"> · FN-3PS2 FN1 Standard Stage Cross travel 30(X) x 30(Y) mm 	<ul style="list-style-type: none"> · C-SR2S Right Handle Stage with 2S Holder · C-CSR15 Right Handle Ceramic-coated Stage with 1S Holder · C-CSR Right Handle Ceramic-coated Stage · NIU-CSRR2 Right Handle Rotatable Ceramic-coated Stage with 2S Holder Cross travel 78(X) x 54(Y) mm Handle height and torque adjustable
		<ul style="list-style-type: none"> · NI-S-E Motorized XY Stage Resolution: 0.1 μm · NI-SH-D Dish Holder (option) 		
Substages		<ul style="list-style-type: none"> · NI-SSR Substage (for Motorized Universal Condenser and Rotatable/Motorized stages) 	<ul style="list-style-type: none"> · NI-SSF Substage for Focusing Nosepiece (for LWD condenser and FN1 Standard/Motorized stages) 	<ul style="list-style-type: none"> · NI-SSR Substage (for Rotatable stage) · NI-SS Substage (for Non-rotatable stages)
Condensers (NA)	Motorized	<ul style="list-style-type: none"> · NI-CUD-E Motorized Universal Condenser Dry (0.88) For DIC, phase contrast, darkfield observations Attached on NI-SSR Substage 	—	—
	Manual	<ul style="list-style-type: none"> · NI-CUD Universal Condenser Dry (0.88) · C-AB Abbe Condenser (0.90) · C-AR Achromat Condenser (0.80) · C-DO Darkfield Condenser Oil (1.20-1.43) · C-DD Darkfield Condenser Dry (0.80-0.95) · C-AA Achromat Aplanatic Condenser (1.40) · C-SA Slide Achromat Condenser 2-100X (0.90) · C-SW Swing-out Achromat Condenser 1-100X (0.90/0.11) · C-SWA Swing-out Achromat Condenser 2-100X (0.90/0.22) · C-LAR LWD Achromat Condenser (0.65) · D-CUO DIC Condenser Oil (1.40) 	<ul style="list-style-type: none"> · FN-C LWD Condenser (0.78) (for DIC and oblique light illumination) 	<ul style="list-style-type: none"> · NI-CUD Universal Condenser Dry (0.88) · C-AB Abbe Condenser (0.90) · C-AR Achromat Condenser (0.80) · C-DO Darkfield Condenser Oil (1.20-1.43) · C-DD Darkfield Condenser Dry (0.80-0.95) · C-AA Achromat Aplanatic Condenser (1.40) · C-SA Slide Achromat Condenser 2-100X (0.90) · C-SW Swing-out Achromat Condenser 1-100X (0.90/0.11) · C-PH Phase Contrast Turret Condenser (0.90)^{*3} · C-SWA Swing-out Achromat Condenser 2-100X (0.90/0.22) · C-LAR LWD Achromat Condenser (0.65) · D-CUO DIC Condenser Oil (1.40)
Epi-fluorescence illuminator	Filter cube turret	<ul style="list-style-type: none"> 6 filter cubes mountable, High S/N noise terminator mechanism for all turrets · NI-FLT6-E Motorized Epi-fluorescence Cube Turret Motorized shutter, Status check function^{*4} · NI-FLT6-I Intelligent Epi-fluorescence Cube Turret Manual shutter, Status check function^{*4} · NI-FLT6 Epi-fluorescence Cube Turret Manual shutter 		
	Light distribution device	<ul style="list-style-type: none"> · NI-FLEI Epi-fluorescence Attachment Aperture diaphragm and field diaphragm (Centerable/Detachable), ND filters (ND4, ND8, ND16) · NI-PAU Ni Photoactivation Unit (405 nm to 650 nm lasers) 		
	Option	<ul style="list-style-type: none"> · NI-BAW-E Motorized Barrier Filter Wheel 7 filters mountable, 0.2 sec between adjacent positions · NI-EXW-E Motorized Excitation Filter Wheel 8 filters mountable, 0.15 sec between adjacent positions · NI-SH-E Motorized Shutter 0.012 sec between open and close state 	<ul style="list-style-type: none"> · NI-SH-E Motorized Shutter 0.012 sec between open and close state 	
Epi-illumination light source		<ul style="list-style-type: none"> · C-LEDFI Epi-Fl LED Illuminator · C-HGFI/HGFIE HG Precentered Fiber Illuminator Intensilight (130W) · Hg Lamphouse and Power Supply (100W)^{*2} · Halogen Lamphouse and Transformer (100W)^{*2} 		
Power consumption		211W (with max. halogen lamp intensity and full motorized options)	96W (with max. halogen lamp intensity and full motorized options)	Main body: 133W (with max. halogen lamp intensity) Control Box B: 29W (with full motorized options)
Weight (approx.)		29 kg (Epi-fluorescent configuration with motorized quadrocular tilting tube)	42 kg (Photoactivation configuration with motorized quadrocular tilting tube)	20 kg (Brightfield configuration with ergonomic binocular tube)

*1 When used with a double layer, such as with layered epi-fluorescence cube turrets, F.O.V. is 22.

*2 Cannot be used with the focusing nosepiece type.

*3 Can only be mounted on the NI-SS Substage.

*4 Status check function: Status of Filter/Nosepiece etc. can be recorded with captured images and/or displayed on the controller monitor.

Unit: mm

Ni-U

Configured with an epi-fluorescence cube turret and quadrocular tilting tube

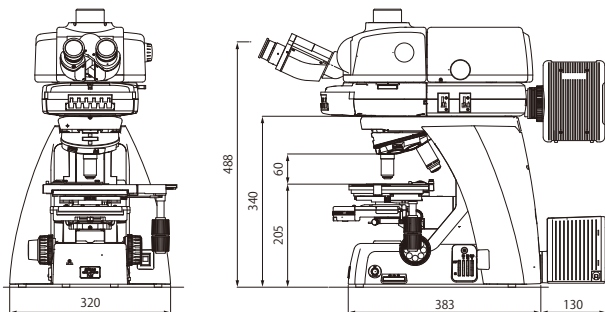

Ni-U

Configured with an ergonomic binocular tube and DSC port

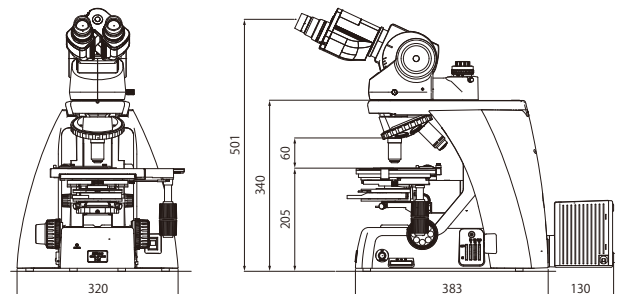

System diagram: Ni-E focusing stage type

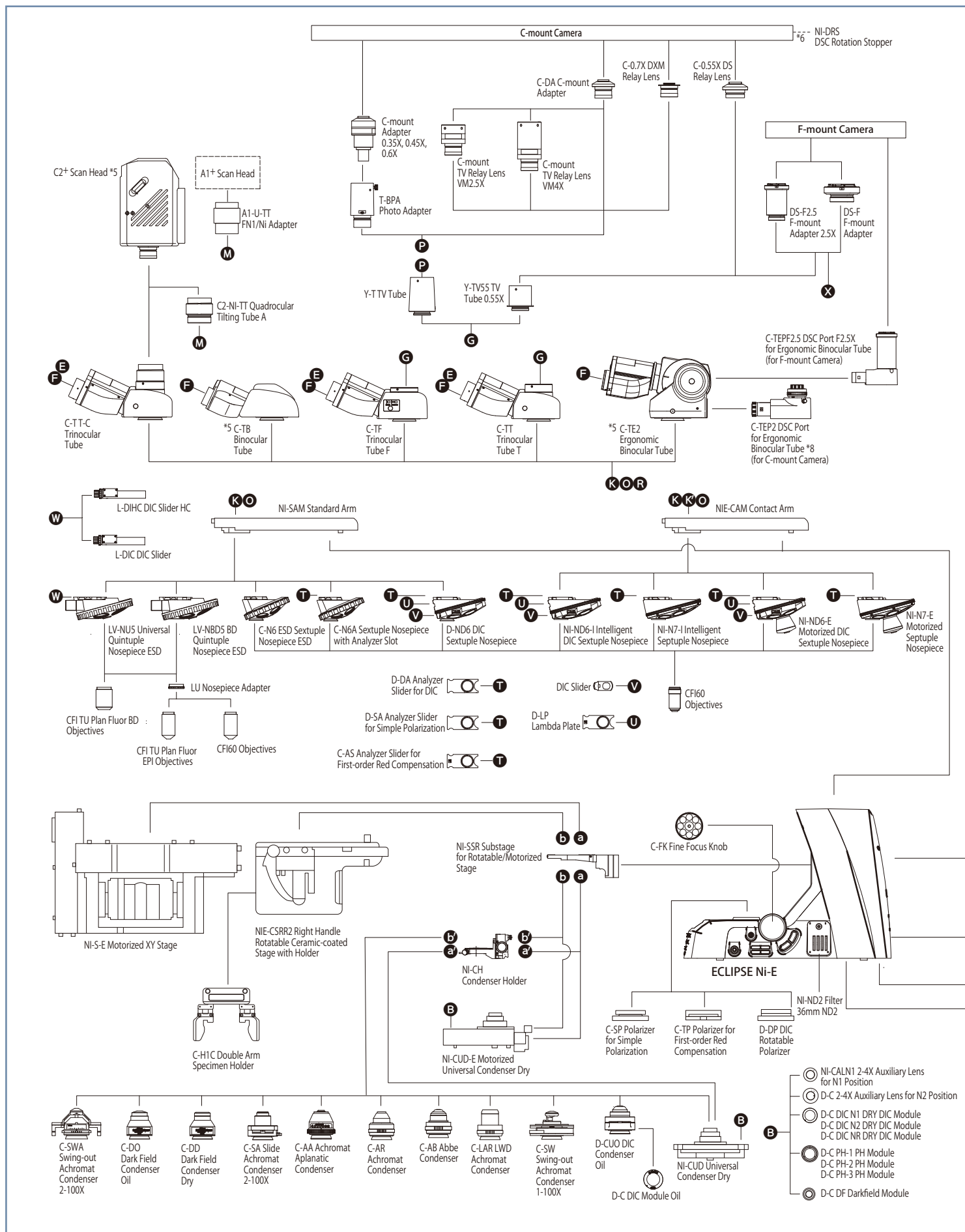

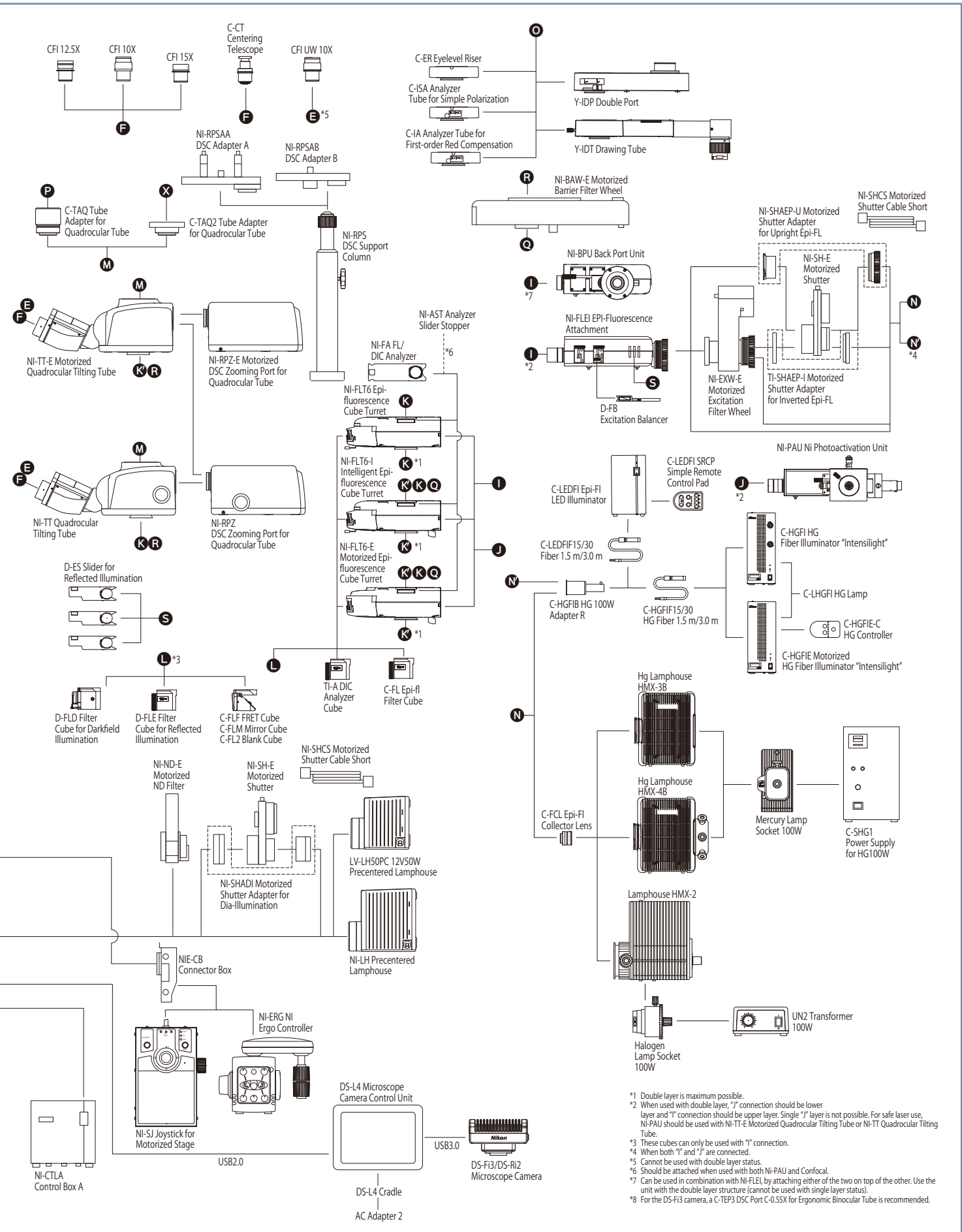

*1 Double layer is maximum possible.
 *2 When used with double layer, "J" connection should be lower layer and "I" connection should be upper layer. Single "J" layer is not possible. For safe laser use, NI-PAU should be used with NI-TT-E Motorized Quadrocular Tilting Tube or NI-TT Quadrocular Tilting Tube.
 *3 These cubes can only be used with "I" connection.
 *4 When both "I" and "J" are connected.
 *5 Cannot be used with double layer status.
 *6 Should be attached when used with both NI-PAU and Confocal.
 *7 Can be used in combination with NI-FLEI, by attaching either of the two on top of the other. Use the unit with the double layer structure (cannot be used with single layer status).
 *8 For the DS-Fi3 camera, a C-TEP3 DSC Port C-0.55X for Ergonomic Binocular Tube is recommended.

System diagram: Ni-E focusing nosepiece type

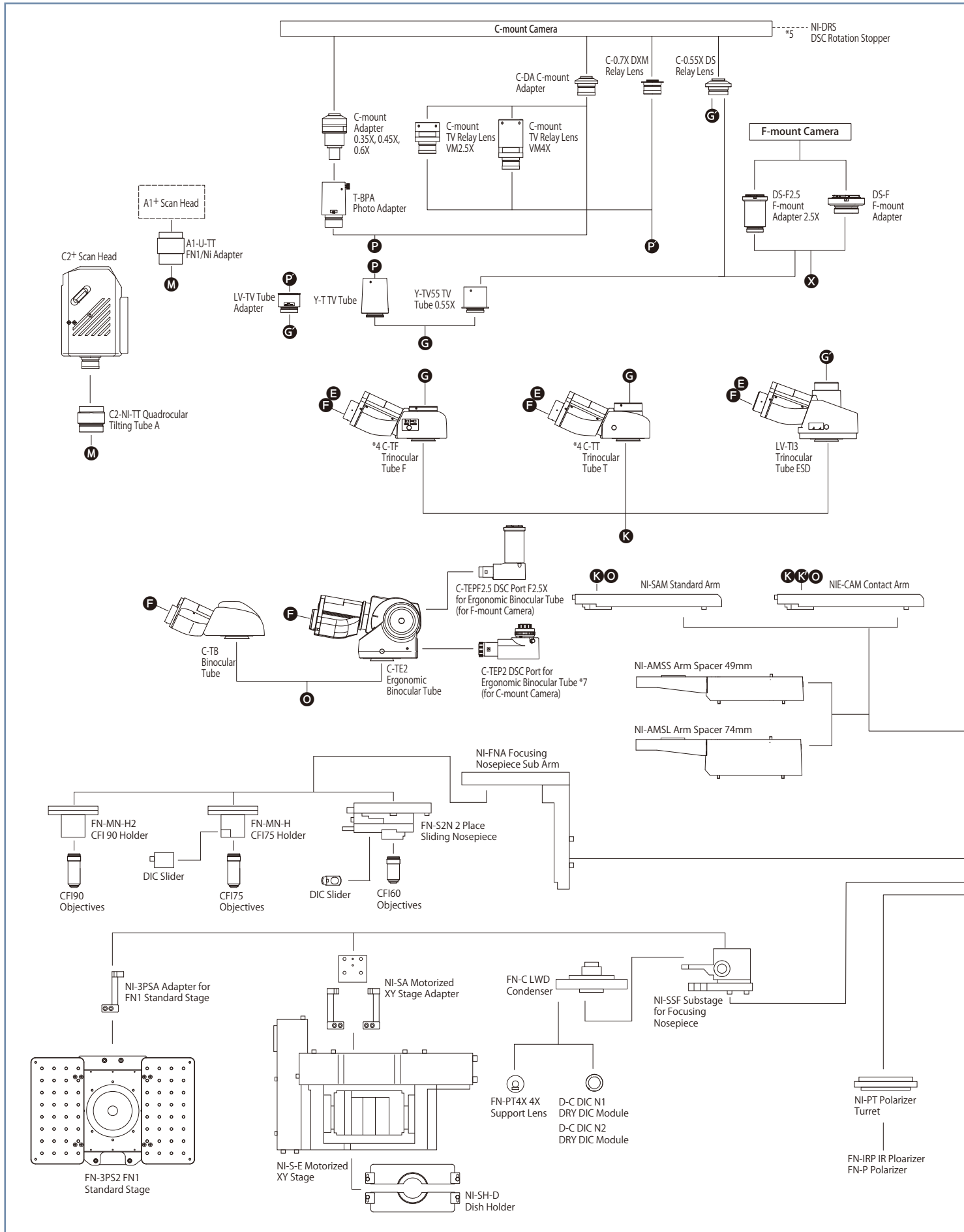

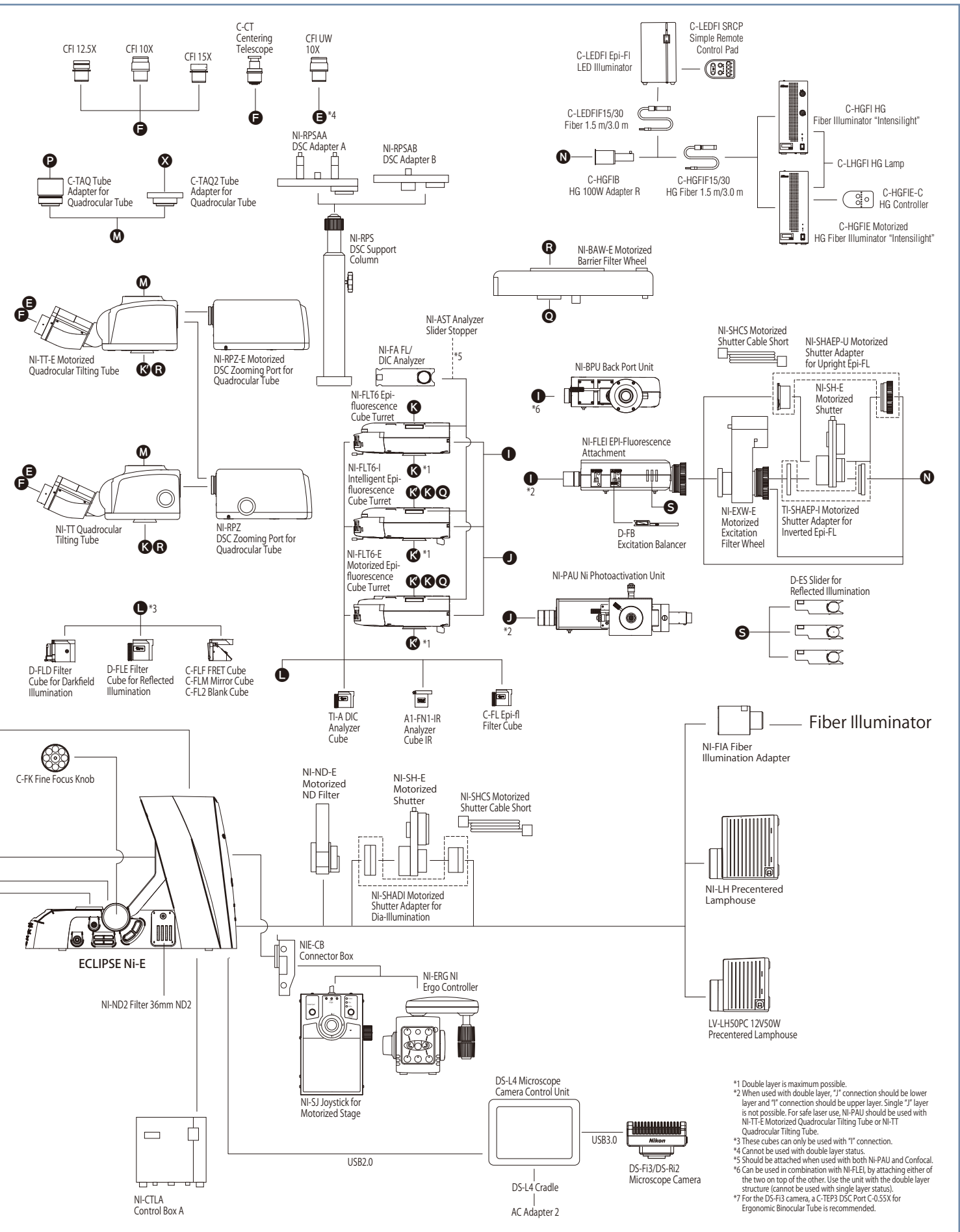

*1 Double layer is maximum possible.
 *2 When used with double layer, "J" connection should be lower layer and "I" connection should be upper layer. Single "J" layer is not possible. For safe laser use, NI-PAU should be used with NI-TT-E Motorized Quadrocular Tilting Tube or NI-TT Quadrocular Tilting Tube.
 *3 These cubes can only be used with "I" connection.
 *4 Cannot be used with double layer status.
 *5 Should be attached when used with both Ni-PAU and Confocal.
 *6 Can be used in combination with NI-FLEI, by attaching either the two on top of the other. Use the unit with the double layer structure (cannot be used with single layer status).
 *7 For the DS-FI3 camera, a C-TEP3 DSC Port C-0.55X for Ergonomic Binocular Tube is recommended.

System diagram: Ni-U

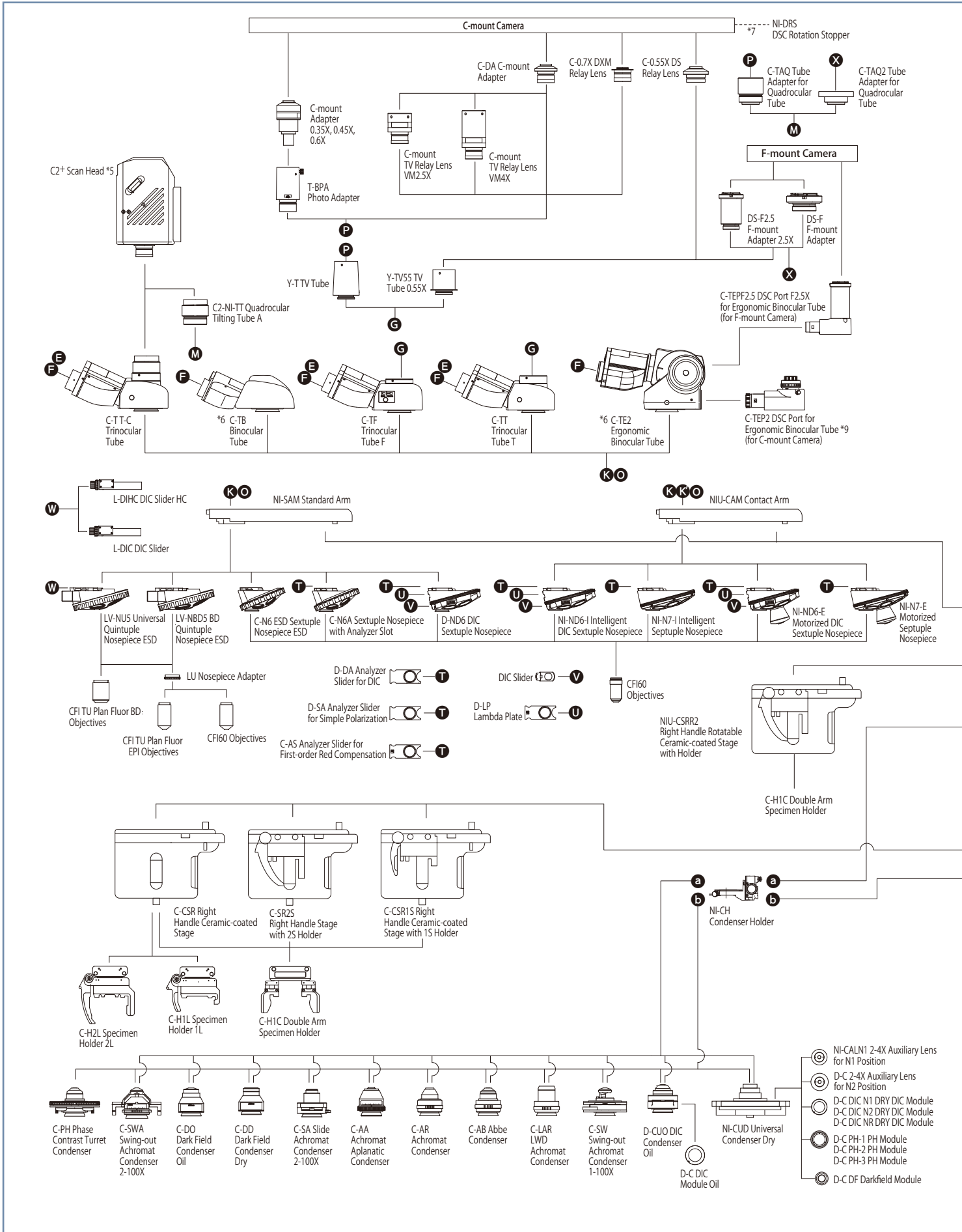

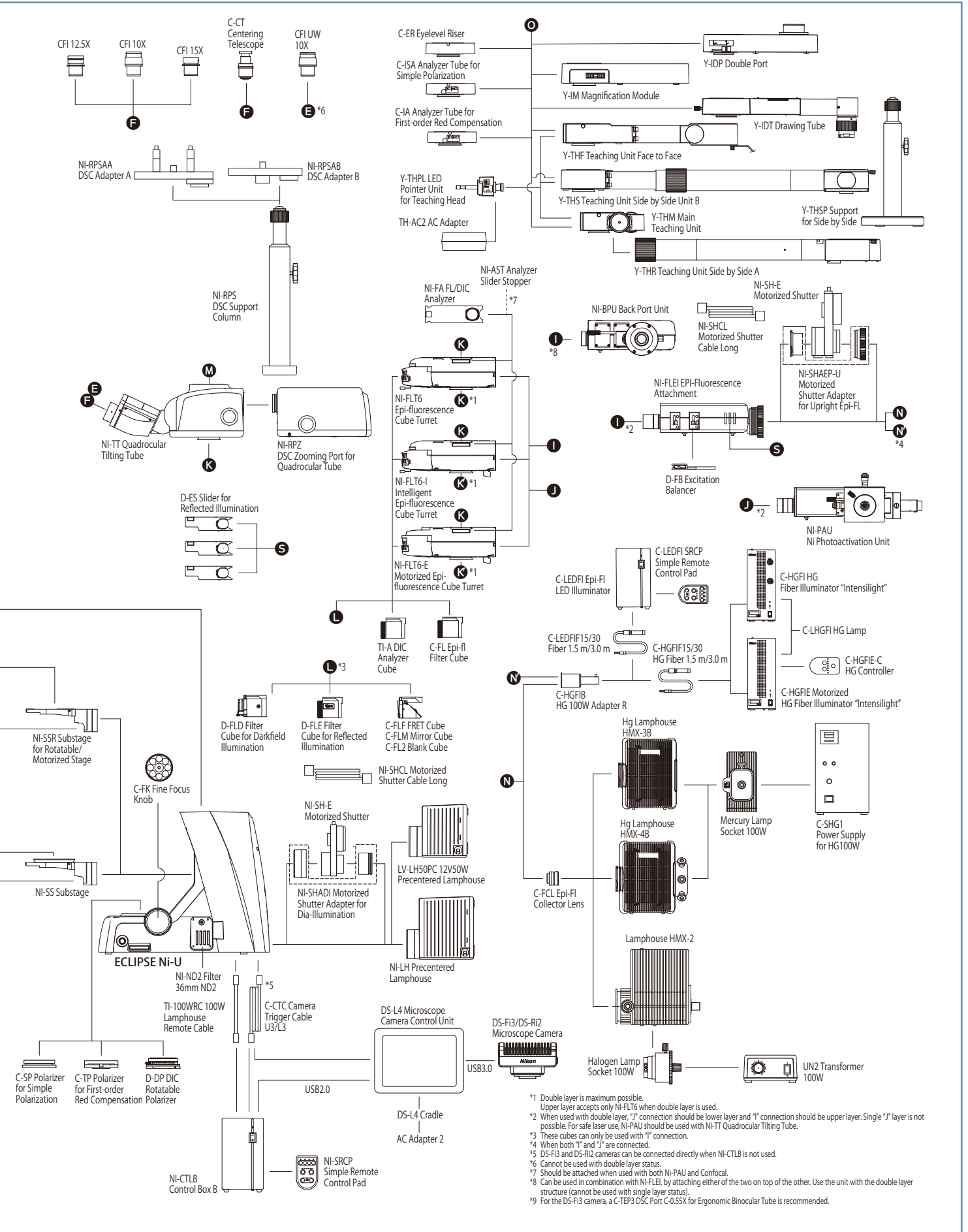

- *1 Double layer is maximum possible. Upper layer accepts only NI-FLT6 when double layer is used.
- *2 When used with double layer, "J" connection should be lower layer and "I" connection should be upper layer. Single "J" layer is not possible. For safe laser use, NI-PAU should be used with NI-TT Quadrocular Tilting Tube.
- *3 These cubes can only be used with "I" connection.
- *4 When both "I" and "J" are connected.
- *5 DS-FI3 and DS-Ri2 cameras can be connected directly when NI-CTLB is not used.
- *6 Cannot be used with double layer status.
- *7 Should be attached when used with both NI-PAU and Confocal.
- *8 Can be used in combination with NI-FLEI, by attaching either of the two on top of the other. Use the unit with the double layer structure (cannot be used with single layer status).
- *9 For the DS-FI3 camera, a C-TEP3 DSC Port C-055X for Ergonomic Binocular Tube is recommended.

Ci Specifications

		Ci-E	Ci-L
Main body	Optical system	CFI60 Infinity Optical System	
	Illumination	High luminescent White LED Illuminator (Eco-illumination)	
		Automatic intensity reproduction function	—
	Controls	Image capture button	
		Nosepiece rotating buttons	—
Remote control pad		—	
Eyepieces (F.O.V. mm)	· CFI 10X (22) · CFI 12.5X (16) · CFI 15X (14.5) · CFI UW 10X (25)		
Focusing	Coaxial Coarse/Fine focusing, Focusing stroke: 30 mm, Coarse: 9.33 mm/rotation, Fine: 0.1 mm/rotation Coarse motion torque adjustable, Refocusing function		
Tubes	F.O.V. 22 mm (Eyepiece/Port)	· C-TB Binocular Tube · C-TE2 Ergonomic Binocular Tube (100/0, 50/50 via optional C-TEP2 DSC Port or C-TEPF2.5 DSC Port F2.5X) Inclination angle: 10-30 degree, Extension: up to 40 mm	
	F.O.V. 25 mm (Eyepiece/Port)	· C-TF Trinocular Tube F (100/0, 0/100) · C-TT Trinocular Tube T (100/0, 20/80, 0/100)	
Nosepieces	· Motorized Sextuple Nosepiece with Analyzer Slot (Within main body) Switching between two objectives function	· C-N6 ESD Sextuple Nosepiece ESD · C-N6A Sextuple Nosepiece with Analyzer Slot	
Stages	Cross travel 78 (X) × 54 (Y) mm, with vernier calibrations, stage handle height and torque adjustable for all stages C-H1C Double Arm Specimen Holder is available as an option for the below three stages. · C-SR2S Right Handle Stage with 2S Holder · C-CSR1S Right Handle Ceramic-coated Stage with 1S Holder · C-CSR Right Handle Ceramic-coated Stage (C-H2L Specimen Holder 2L and C-H1L Specimen Holder 1L can be attached)		
Condensers (NA)	Motorized	· CI-C-E Motorized Swing-out Condenser (0.90/0.22) Focusing stroke: 27 mm	—
	Manual	Focusing stroke: 27 mm · C-AB Abbe Condenser (0.90) · C-AR Achromat Condenser (0.80) · C-DO Darkfield Condenser Oil (1.20-1.43) · C-DD Darkfield Condenser Dry (0.80-0.95) · C-PH Phase Contrast Turret Condenser (0.90) · C-AA Achromat/ Aplanat Condenser (1.40) · C-SA Slide Achromat Condenser 2-100X (0.90) · C-SW Swing-out Achromat Condenser 1-100X (0.90/0.11) · C-SWA Swing-out Achromat Condenser 2-100X (0.90/0.22) · C-LAR LWD Achromat Condenser (0.65)	
Observation methods*	Brightfield, Epi-fluorescence, Darkfield, Phase contrast, Simple polarizing, Sensitive color polarizing		
Epi-fluorescence attachment	· CI-FL Epi-fluorescence Attachment (4 filter cubes mountable) · D-FL Epi-fluorescence Attachment (6 filter cubes mountable) ND4/ND8/ND16 filters, Noise Terminator mechanism		
Epi-fluorescence light source	· C-LEDFI Epi-Fl LED Illuminator · C-HGFI/HGFIE HG Precentered Fiber Illuminator Intensilight (130W) · Hg Lamphouse and Power Supply (100W)		
Power consumption	13W (Brightfield configuration)		6W (Brightfield configuration)
Weight (approx.)	15.4 kg (Binocular standard set)		13.4 kg (Binocular standard set)

*Observations except Brightfield require optional accessories.

Ci Dimensional Diagram

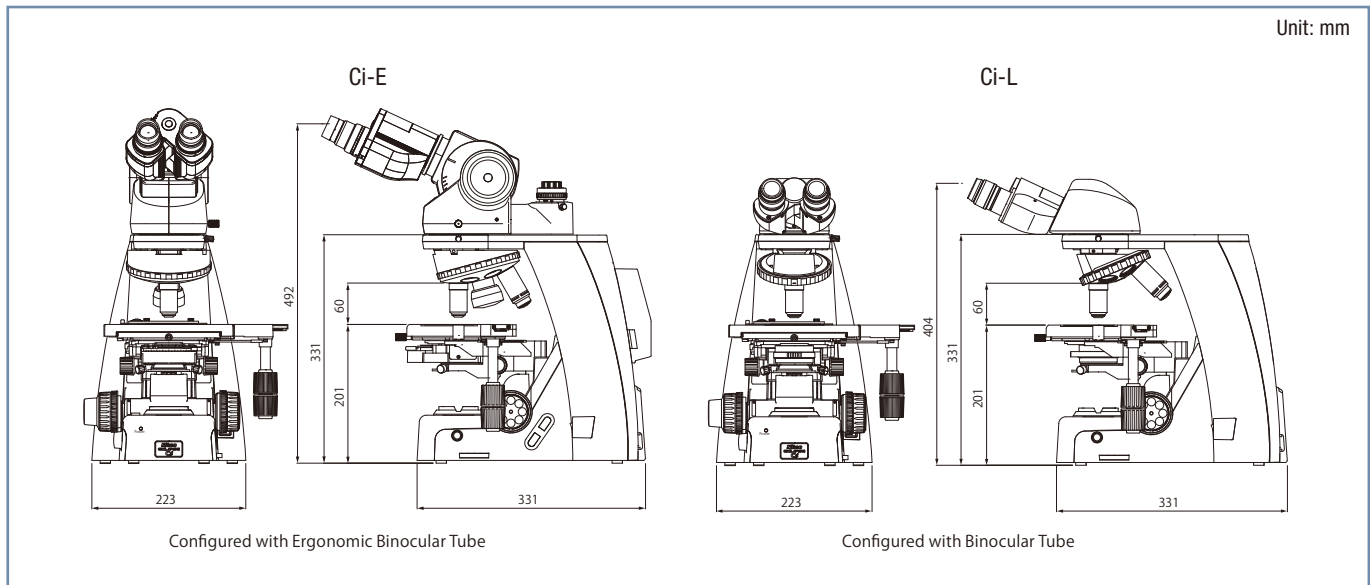

Ci System Diagram

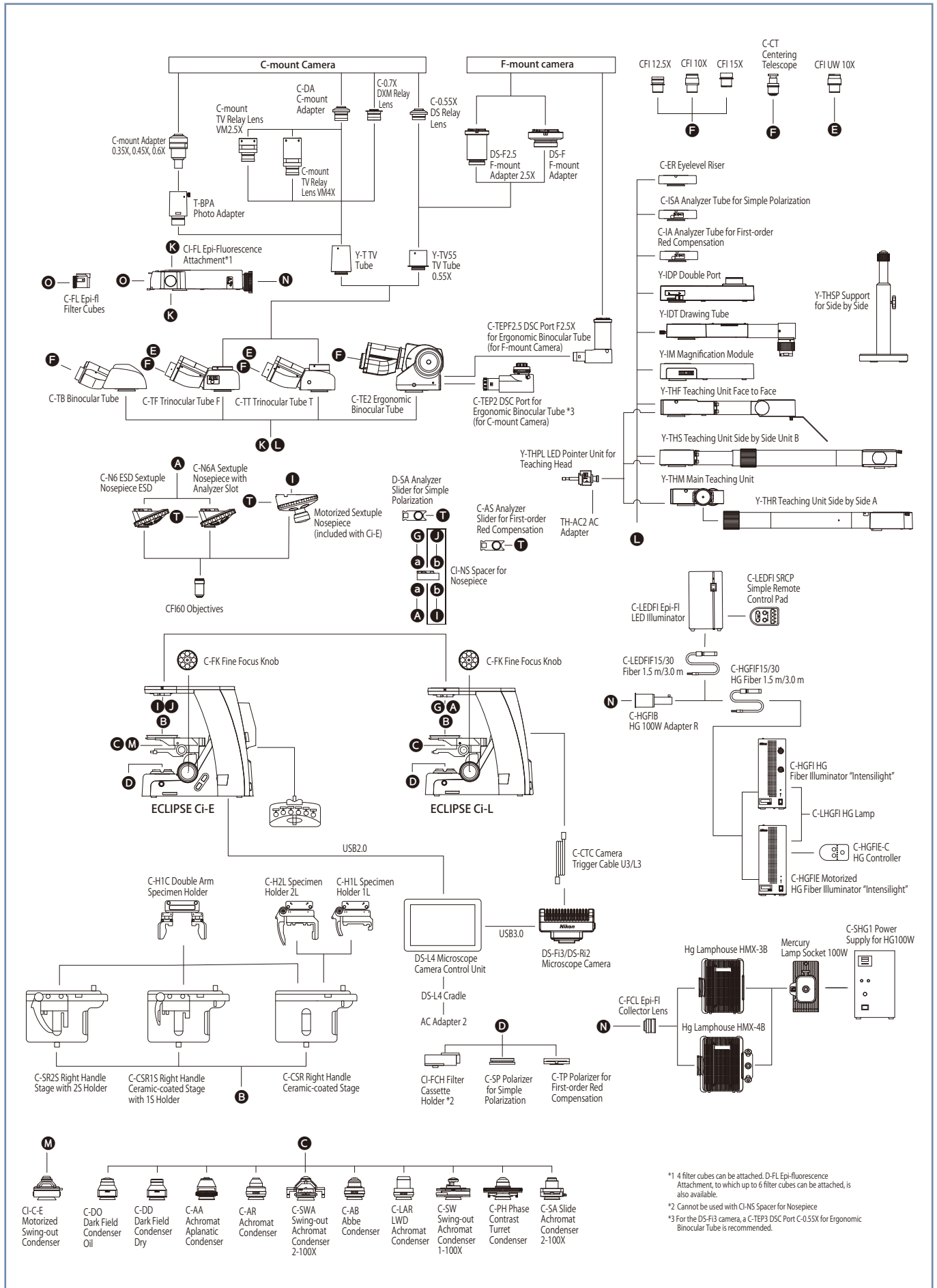

*1 4 filter cubes can be attached. D-FL Epi-fluorescence Attachment, to which up to 6 filter cubes can be attached, is also available.

*2 Cannot be used with C-NS Spacer for Nosepiece

*3 For the DS-F13 camera, a C-TEP3 DSC Port C-0.55X for Ergonomic Binocular Tube is recommended.



WWW.HOSKIN.CA

- INTEGRATED SYSTEMS • RENTALS • SERVICE
- ENVIRONMENTAL • INSTRUMENTATION • MATERIALS TESTING

Vancouver | Burlington | Montréal | Edmonton